

| HOUSING | OPERATING DISTANCE | MOUNTING | ✓ One-piece housing in stainless steel V2A | ✓ Extremely robust |
|---------|--------------------|------------|--|--------------------|
| M18 | 5 mm | Embeddable | ✓ Long operating distance | ✓ Water resistant |
| | | | ✓ Factor 1 on Fe and Al | ✓ IP68/IP69K |
| | | | | ✓ IO-Link v1.1 |

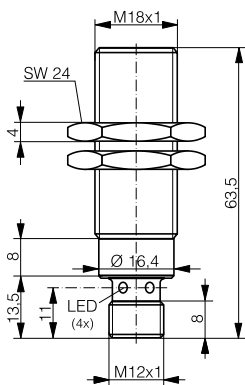

DW-AS-70x-M18-303

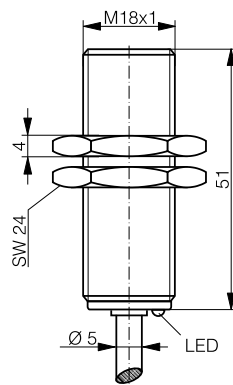

DW-AD-70x-M18-303

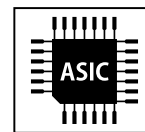

| DETECTION DATA | | INTERFACE | |
|--------------------------------------|---------------------------------------|---------------------------------|---|
| Rated operating distance (S_n) | 5 mm | Indicator LED, yellow | Sensing state ($0 \leq s \leq 0.8 S_r$) |
| Assured operating distance (S_a) | $\leq (0.81 \times S_n)$ mm | Indicator LED, yellow, blinking | Sensing state ($0.8 S_r < s \leq S_r$) |
| Repeat accuracy | ≤ 0.3 mm | IO-Link | ✓ |
| Hysteresis | $3\% S_r < \text{Hyst} \leq 15\% S_r$ | MTTF (@40°C) | 1028 y |
| Temperature drift | $\leq 10\% S_r$ | | |
| Standard target | 18 x 18 x 1 mm ³ , FE360 | | |

Note: $0.9S_n \leq S_a \leq 1.1S_n$.

| ELECTRICAL DATA | | MECHANICAL DATA | |
|--------------------------------|-----------------|-------------------------------|--------------------------|
| Supply voltage range (U_B) | 10...30 VDC | Mounting | Embeddable |
| Residual ripple | $\leq 20\% U_B$ | Housing material | V2A / 1.4305 / AISI 303 |
| Output current | ≤ 200 mA | Sensing face material | V2A / 1.4305 / AISI 303 |
| Output voltage drop | ≤ 2.0 VDC | Max tightening torque | 50 Nm |
| Power consumption (no-load) | ≤ 10 mA | Ambient operating temperature | -25...+85°C ¹ |
| Residual current | ≤ 0.1 mA | Enclosure rating | IP68 / IP69K |
| Switching frequency | ≤ 500 Hz | Weight (cable/connector) | see page 2 |
| Short-circuit protection | ✓ | Shock and vibration | IEC 60947-5-2 / 7.4 |
| Voltage reversal protection | ✓ | | |
| Cable length max. | ≤ 300 m | | |

¹Maximum temperature according to UL: 70°C.

Note: all data measured according to IEC 60947-5-2 standard with $U_B=20 \dots 30$ VDC, $T_A=23^\circ\text{C} \pm 5^\circ\text{C}$.

CORRECTION FACTORS FOR TARGET OF

| | | | | | | | | | |
|--------------|---|--------|-----|----------|---|-------|-----|----------------------------|-----------|
| Steel FE 360 | 1 | Copper | 0.8 | Aluminum | 1 | Brass | 1.3 | Stainless Steel V2A 1/2 mm | 0.3 / 0.7 |
|--------------|---|--------|-----|----------|---|-------|-----|----------------------------|-----------|

CORRECTION FACTORS FOR EMBEDDABLE MOUNTING IN SUPPORT OF

| | | | | | | | |
|--------------|-----|----------|-----|-------|-----|---------------------|-----|
| Steel FE 360 | 0.9 | Aluminum | 0.9 | Brass | 0.9 | Stainless Steel V2A | 0.9 |
|--------------|-----|----------|-----|-------|-----|---------------------|-----|

Note: the operating distance of the sensor must be multiplied by the correction factor of the material. For example, the operating distance on Aluminum is $S_{n,Al} = S_n \times CF_{Al}$. In case of embeddable mounting, the distance is multiplied by the additional correction factor of the support, thus $S_{n,Al} = S_n \times CF_{Al} \times CF_{emb,Al}$.

INSTALLATION CONDITIONS

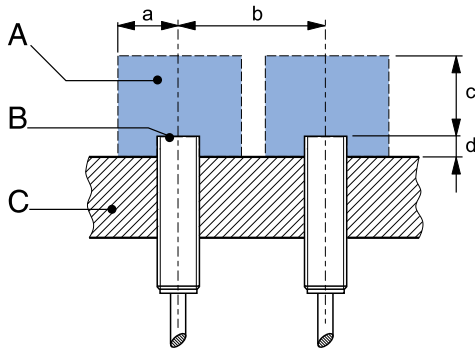

A : metal free zone a : 15 mm d : steel 0 mm
 B : sensing face b : 30 mm
 C : support c : 15 mm

Note: additional installation information can be found in the glossary of the Contrinex General Catalog.

IO-LINK FUNCTIONALITIES

| | |
|--------------------|-------------------|
| IO-Link version | 1.1 |
| SIO mode | Supported |
| Process data | 7-bit input |
| Baudrate | COM2 (38.4 kBaud) |
| Minimum cycle time | 10.4 ms |
| ISDU | Not supported |



IO-Link files may be downloaded from

www.contrinex.com/product-range/inductive-sensors/.

Select the product name to display the product page with corresponding downloads.

Alternatively, just click/scan the QR code on the left.

WIRING DIAGRAM

PIN ASSIGNMENT

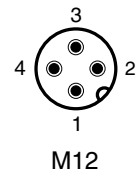
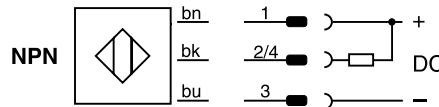
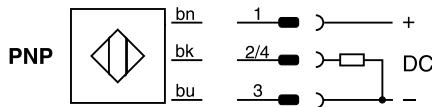

AVAILABLE TYPES

| Part number | Part reference | Polarity | Connection | Output on pin 2 | Output on pin 4 / bk | Weight |
|-------------|-------------------|----------|------------------|-----------------|------------------------------|--------|
| 320-420-431 | DW-AD-701-M18-303 | NPN | PUR, 2 m, 3 wire | - | Normally open (NO) | 115 g |
| 330-320-066 | DW-AD-703-M18-303 | PNP | PUR, 2 m, 3 wire | - | Normally open (NO) / IO-Link | 115 g |
| 320-420-435 | DW-AS-701-M18-303 | NPN | M12 4-pin | - | Normally open (NO) | 53 g |
| 330-320-067 | DW-AS-703-M18-303 | PNP | M12 4-pin | - | Normally open (NO) / IO-Link | 53 g |

Note: part reference may include additional suffix to indicate a revision version or special version. Further information is available on request.

Operators of the products we supply are responsible for compliance with measures for the protection of persons. The use of our equipment in applications where the safety of persons might be at risk is only authorized if the operator observes and implements separate, appropriate and necessary measures for the protection of persons and machines. Terms of delivery and rights to change design reserved.