

HOUSING	OPERATING DISTANCE	MOUNTING	✓ One-piece housing in stainless steel V2A	✓ Extremely robust
M30	10 mm	Embeddable	✓ Long operating distance	✓ Water resistant
			✓ Factor 1 on Fe and Al	✓ IP68/IP69K
				✓ IO-Link v1.1

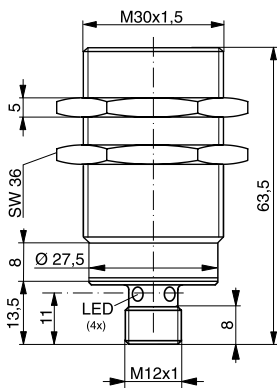

DW-AS-70x-M30-303

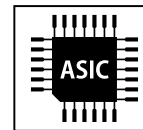
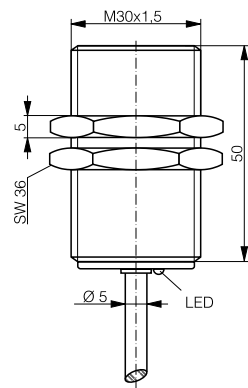

DW-AD-70x-M30-303

DETECTION DATA		INTERFACE	
Rated operating distance (S_n)	10 mm	Indicator LED, yellow	Sensing state ($0 \leq s \leq 0.8 S_r$)
Assured operating distance (S_a)	$\leq (0.81 \times S_n)$ mm	Indicator LED, yellow, blinking	Sensing state ($0.8 S_r < s \leq S_r$)
Repeat accuracy	≤ 0.3 mm	IO-Link	✓
Hysteresis	$3\% S_r < \text{Hyst} \leq 15\% S_r$	MTTF (@40°C)	1028 y
Temperature drift	$\leq 10\% S_r$		
Standard target	30 x 30 x 1 mm ³ , FE360		

Note: $0.9S_n \leq S_a \leq 1.1S_n$.

ELECTRICAL DATA		MECHANICAL DATA	
Supply voltage range (U_B)	10...30 VDC	Mounting	Embeddable
Residual ripple	$\leq 20\% U_B$	Housing material	V2A / 1.4305 / AISI 303
Output current	≤ 200 mA	Sensing face material	V2A / 1.4305 / AISI 303
Output voltage drop	≤ 2.0 VDC	Max tightening torque	150 Nm
Power consumption (no-load)	≤ 10 mA	Ambient operating temperature	-25...+85°C ¹
Residual current	≤ 0.1 mA	Enclosure rating	IP68 / IP69K
Switching frequency	≤ 250 Hz	Weight (cable/connector)	see page 2
Short-circuit protection	✓	Shock and vibration	IEC 60947-5-2 / 7.4
Voltage reversal protection	✓		
Cable length max.	≤ 300 m		

¹Maximum temperature according to UL: 70°C.

Note: all data measured according to IEC 60947-5-2 standard with $U_B=20 \dots 30$ VDC, $T_A=23^\circ\text{C} \pm 5^\circ\text{C}$.

CORRECTION FACTORS FOR TARGET OF

Steel FE 360	1	Copper	0.8	Aluminum	1	Brass	1.3	Stainless Steel V2A 1/2 mm	0.4 / 0.6
--------------	---	--------	-----	----------	---	-------	-----	----------------------------	-----------

CORRECTION FACTORS FOR EMBEDDABLE MOUNTING IN SUPPORT OF

Steel FE 360	0.9	Aluminum	0.8	Brass	0.8	Stainless Steel V2A	0.9
--------------	-----	----------	-----	-------	-----	---------------------	-----

Note: the operating distance of the sensor must be multiplied by the correction factor of the material. For example, the operating distance on Aluminum is $S_{n,Al} = S_n \times CF_{Al}$. In case of embeddable mounting, the distance is multiplied by the additional correction factor of the support, thus $S_{n,Al} = S_n \times CF_{Al} \times CF_{emb,Al}$.

INSTALLATION CONDITIONS

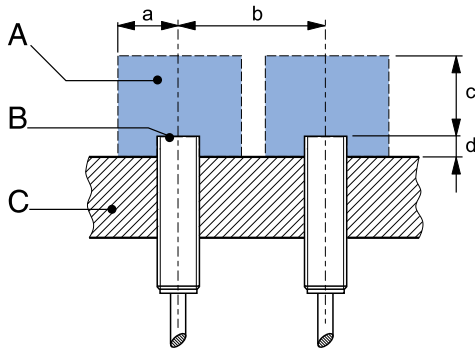

A : metal free zone a : 35 mm d : steel 0 mm
 B : sensing face b : 60 mm
 C : support c : 30 mm

Note: additional installation information can be found in the glossary of the Contrinex General Catalog.

IO-LINK FUNCTIONALITIES

IO-Link version	1.1
SIO mode	Supported
Process data	7-bit input
Baudrate	COM2 (38.4 kBaud)
Minimum cycle time	10.4 ms
ISDU	Not supported



IO-Link files may be downloaded from

www.contrinex.com/product-range/inductive-sensors/.

Select the product name to display the product page with corresponding downloads.

Alternatively, just click/scan the QR code on the left.

WIRING DIAGRAM

PIN ASSIGNMENT

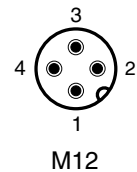
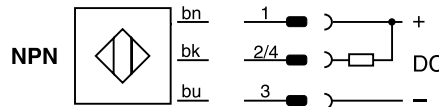
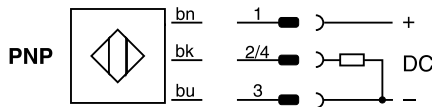

AVAILABLE TYPES

Part number	Part reference	Polarity	Connection	Output on pin 2	Output on pin 4 / bk	Weight
320-420-447	DW-AD-701-M30-303	NPN	PUR, 2 m, 3 wire	-	Normally open (NO)	190 g
330-320-069	DW-AD-703-M30-303	PNP	PUR, 2 m, 3 wire	-	Normally open (NO) / IO-Link	190 g
320-420-450	DW-AD-704-M30-303	PNP	PUR, 2 m, 3 wire	Normally close (NC)	-	190 g
320-420-451	DW-AS-701-M30-303	NPN	M12 4-pin	-	Normally open (NO)	137 g
330-320-070	DW-AS-703-M30-303	PNP	M12 4-pin	-	Normally open (NO) / IO-Link	137 g

Note: part reference may include additional suffix to indicate a revision version or special version. Further information is available on request.

Operators of the products we supply are responsible for compliance with measures for the protection of persons. The use of our equipment in applications where the safety of persons might be at risk is only authorized if the operator observes and implements separate, appropriate and necessary measures for the protection of persons and machines. Terms of delivery and rights to change design reserved.