

Datasheet - Z1R 235-11Z



Position switch / 235 Metal enclosure - DIN EN 50047 with Actuator / 235 Offset roller lever 1r



- Metal enclosure
- Wide range of alternative actuators
- Good resistance to oil and petroleum spirit
- 30 mm x 63,5 mm x 30 mm
- Snap action with constant contact pressure up to switching point
- Actuator heads can be repositioned by 4 x 90°
- Mounting details to EN 50047
- 1 Cable entry M 20 x 1.5

(Minor differences between the printed image and the original product may exist!)

Ordering details

Product type description	Z1R 235-11Z
Article number	1166167
EAN code	4030661213378

Approval

Approval



Classification

Standards	EN ISO 13849-1
B _{10d} Opener (NC)	20.000.000
Mission time notice	20 Years
	$MTTF_d = \frac{B_{10d}}{0,1 \times n_{op}}$ $n_{op} = \frac{d_{op} \times h_{op} \times 3600 \text{ s/h}}{t_{zyklus}}$

Global Properties

Product name	Z 235 Rollenhebel 1R
Standards	EN 60947-5-1 BG-GS-ET-15

Compliance with the Directives (Y/N) 	Yes
Suitable for safety functions (Y/N)	Yes
Materials	
- Material of the housings	Zink
- Material of the contacts	Silver
Housing coating	painted
Housing construction form	Norm construction design
Weight	150 g

Mechanical data

Design of actuating element	Offset roller lever
Design of electrical connection	Screw connection
Cable section	
- Min. Cable section	0,75 mm ²
- Max. Cable section	2.5 mm ²
Mechanical life	20.000.000 operations
Switching frequency	max. 5000 /h
Actuating force	min. 9 N
Bounce duration	< 3 ms
Switchover time	> 5.5 ms
Positive break force	19 N
Actuating speed with actuating angle 30° to switch axis	
- Min. Actuating speed	27 mm/min
- Max. Actuating speed	1 m/s
notice	All indications about the cable section are including the conductor ferrules.

Ambient conditions

Ambient temperature	
- Min. environmental temperature	- 30°C
- Max. environmental temperature	+ 80°C
Protection class	IP67

Electrical data

Design of control element	Normally open contact (NO), Opener (NC)
Switching principle	Snap switch element
- positive break NC contact 	
Number of auxiliary contacts	1 piece
Number of safety contacts	1 piece
Rated impulse withstand voltage U _{imp}	6 kV
Rated insulation voltage U _i	500 V
Thermal test current I _{the}	10 A
Utilisation category	AC-15: 230 V / 4 A, DC-13: 24 V / 1 A
Max. fuse rating	6 A gG D-fuse

ATEX

Explosion protection categories for gases	None
Explosion protected category for dusts	None

Dimensions

Dimensions of the sensor

- Width of sensor	30 mm
- Height of sensor	91.5 mm
- Length of sensor	30 mm

Diagram

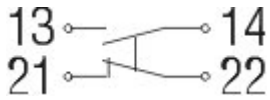

Note Diagram

- positive break NC contact
- active
- no active
- Normally-open contact
- Normally-closed contact

Switch travel diagram

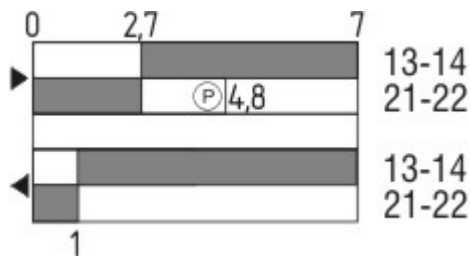

Notes Switch travel diagram

- Contact closed
 - Contact open
 - Setting range
 - Break point
 - Positive opening sequence/- angle
- VS** adjustable range of NO contact
VÖ adjustable range of NC contact
N after travel

Ordering suffix

The applicable ordering suffix is added at the end of the part number of the safety switch.

Order example: Z1R 235-11Z-**1637**

...-**1637**

0,3 µm gold-plated contacts

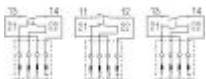

...-**ST**

M12 connector with A-coding

Rated impulse withstand voltage U_{imp} : 0,8 kV

Rated insulation voltage U_i : 50 V

Operating current I_e : AC-15: 50 V / 4 A

Caution! The versions with connector may only be used in PELV circuits to EN 60204-1.

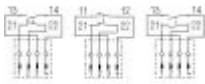

M12 connector with B-coding
Rated impulse withstand voltage U_{imp} : 0,8 kV
Rated insulation voltage U_i : 50 V
Operating current I_e : AC-15: 50 V / 4 A
Caution! The versions with connector may only be used in PELV circuits to EN 60204-1.

...-2310

...-NPT

Cable entry NPT 1/2"

...-1297

Enclosure with transverse slotted holes

Ordering code

(1)(2) 2(3)5-(4)Z(5)-(6)-(7)-(8)-(9)

(1)

Z Snap action

T Slow action

(2)

S Plunger S

R Roller plunger R

4S Plunger 4S

4R Roller plunger 4R

1R Offset roller lever 1R

K Offset roller lever K

3K Angle roller lever 3K

4K Angle roller lever 4K

K4 Angle roller lever K4

1H Roller lever 1H

7H Roller lever 7H

10H Rod lever 10H

12H Roller lever 12H

14H Roller lever 14H

(3)

3 slim design

5 large design

(4)

02 2 Opener (NC)

11 1 Normally open contact (NO) / 1 Opener (NC)

20 2 Normally open contact (NO), (Switch with 2 NO contacts are not for security tasks)

(5)

H Slow action with staggered contacts

UE Slow action with overlapping contacts

(6)

without Cable entry M20

ID IDC method of termination

NPT cable entry NPT 1/2"

ST M12 connector with A-coding (Caution! The versions with connector may only be used in PELV circuits to EN 60204-1.)

2310 M12 connector with B-coding (Caution! The versions with connector may only be used in PELV circuits to EN 60204-1.)

(7)

1297 Enclosure with transverse slotted holes

(8)

2138 Roller lever 7H for Position switches with safety function

(9)

1637 gold-plated contacts

Documents

Operating instructions and Declaration of conformity (de) 644 kB, 06.04.2010

http://www.schmersal.net/Bilddata/Si_f1/Pdf/Zt235/bedien/DE/mrl_ZT235_236_de.pdf

Operating instructions and Declaration of conformity (pt) 451 kB, 01.03.2010

http://www.schmersal.net/Bilddata/Si_f1/Pdf/Zt235/bedien/PT/mrl_ZT235_236_pt.pdf

Operating instructions and Declaration of conformity (nl) 383 kB, 27.11.2009

http://www.schmersal.net/Bilddata/Si_f1/Pdf/Zt235/bedien/NL/mrl_ZT235_236_nl.pdf

Operating instructions and Declaration of conformity (en) 535 kB, 01.03.2010

http://www.schmersal.net/Bilddata/Si_f1/Pdf/Zt235/bedien/EN/mrl_ZT235_236_en.pdf

Operating instructions and Declaration of conformity (es) 391 kB, 27.11.2009

http://www.schmersal.net/Bilddata/Si_f1/Pdf/Zt235/bedien/ES/mrl_ZT235_236_es.pdf

Operating instructions and Declaration of conformity (fr) 399 kB, 27.11.2009

http://www.schmersal.net/Bilddata/Si_f1/Pdf/Zt235/bedien/FR/mrl_ZT235_236_fr.pdf

Operating instructions and Declaration of conformity (it) 375 kB, 27.11.2009

http://www.schmersal.net/Bilddata/Si_f1/Pdf/Zt235/bedien/IT/mrl_ZT235_236_it.pdf

Operating instructions and Declaration of conformity (jp) 562 kB, 27.11.2009

http://www.schmersal.net/Bilddata/Si_f1/Pdf/Zt235/bedien/JP/mrl_ZT235_236_jp.pdf

CCC certification (en) 584 kB, 12.12.2006

http://www.schmersal.net/Bilddata/Si_f1/Pdf/Zt235/zertifikat/q_347p02.pdf

CCC certification (cn) 605 kB, 12.12.2006

http://www.schmersal.net/Bilddata/Si_f1/Pdf/Zt235/zertifikat/q_347p03.pdf

Images

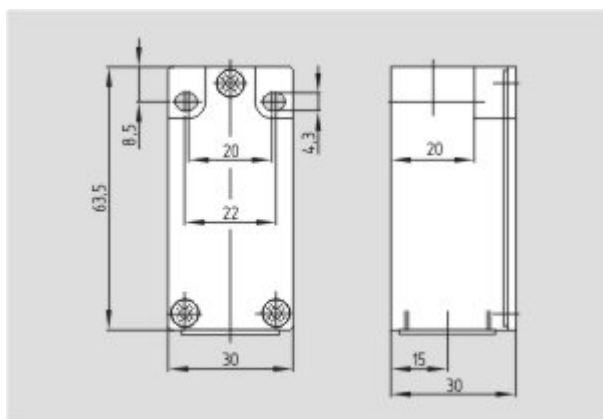

Dimensional drawing (basic component)

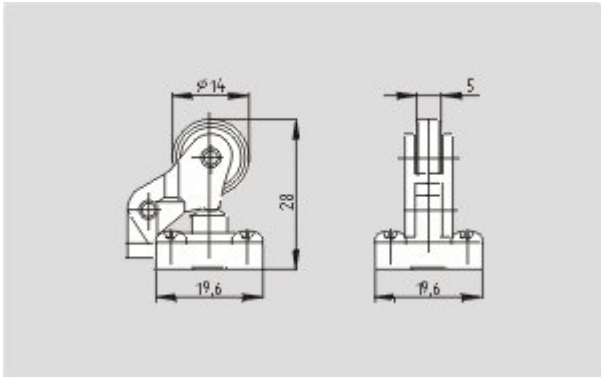

Dimensional drawing (actuator)

K.A. Schmersal GmbH, Möddinghofe 30, D-42279 Wuppertal

The data and values have been checked thoroughly. Technical modifications and errors excepted.

Generiert am 13.04.2010 - 17:50:58h Kasbase 1.3.5 DBI