

Datasheet - TR 335-11z



Position switch / 335 Metal enclosure - DIN EN 50041 with Actuator / 335 Roller plunger r



- Metal enclosure
- Wide range of alternative actuators
- Good resistance to oil and petroleum spirit
- 40,5 mm x 76 mm x 38 mm
- Actuator heads can be repositioned by 4 x 90°
- 1 Cable entry M 20 x 1.5
- Design to EN 50041

(Minor differences between the printed image and the original product may exist!)

Ordering details

Product type description	TR 335-11Z
Article number	1167924
EAN code	4030661219714

Approval

Approval	 USA/CAN  CCC
----------	--

Classification

Standards	EN ISO 13849-1
B _{10d} Normally-closed contact (NC)	20.000.000
Mission time notice	20 Years
	$MTTF_d = \frac{B_{10d}}{0,1 \times n_{op}}$ $n_{op} = \frac{d_{op} \times h_{op} \times 3600 \text{ s/h}}{t_{zyklus}}$

Global Properties

Product name	T 335 Druckbolzen R
Standards	EN 60947-5-1, BG-GS-ET-15

Compliance with the Directives (Y/N) 	Yes
Suitable for safety functions (Y/N)	Yes
Actuator type	C to EN 50041
Materials	
- Material of the housings	Aluminium
- Material of the contacts	Silver
Housing coating	painted
Housing construction form	Norm construction design
Weight	185 g

Mechanical data

Design of actuating element	Roller plunger
Design of electrical connection	Screw connection
Cable section	
- Min. Cable section	0,75 mm ²
- Max. Cable section	2.5 mm ²
Mechanical life	30.000.000 operations
Switching frequency	max. 5000 /h
Actuating force	min. 17 N
Bounce duration	< 2 ms
Switchover time	in accordance with actuating speed
Actuating speed with actuating angle 30° to switch axis	
- Min. Actuating speed	
- Max. Actuating speed	0,5 m/s
notice	All indications about the cable section are including the conductor ferrules.

Ambient conditions

Ambient temperature	
- Min. environmental temperature	- 30°C
- Max. environmental temperature	+ 80°C
Protection class	IP67

Electrical data

Design of control element	Normally open contact (NO), Opener (NC)
Switching principle	Slow action
- positive break NC contact 	
Number of auxiliary contacts	1 piece
Number of safety contacts	1 piece
Rated impulse withstand voltage U _{imp}	6 kV
Rated insulation voltage U _i	500 V
Thermal test current I _{the}	10 A
Utilisation category	AC-15: 230 V / 4 A, DC-13: 24 V / 4 A
Max. fuse rating	6 A gG D-fuse

ATEX

Explosion protection categories for gases	None
Explosion protected category for dusts	None

Dimensions

Dimensions of the sensor

- Width of sensor	40.5 mm
- Height of sensor	116.6 mm
- Length of sensor	38 mm



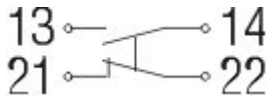

notice

The positioning of the head must be carried out in factory.

Diagram







Note Diagram

-  positive break NC contact
-  active
-  no active
-  Normally-open contact
-  Normally-closed contact

Switch travel diagram



Notes Switch travel diagram

-  Contact closed
 -  Contact open
 -  Setting range
 -  Break point
 -  Positive opening sequence/- angle
- VS** adjustable range of NO contact
VÖ adjustable range of NC contact
N after travel

Ordering suffix

The applicable ordering suffix is added at the end of the part number of the safety switch.

Order example: TR 335-11z-**1637**

...-**1637** 0,3 µm gold-plated contacts

...-**NPT** Cable entry NPT 1/2"

M12 connector with B-coding
Rated impulse withstand voltage U_{imp} : 0,8 kV
Rated insulation voltage U_i : 50 V
Operating current I_e : AC-15: 50 V / 4 A

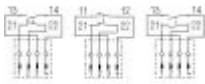

Caution! The versions with connector may only be used in PELV circuits to EN 60204-1.

...-2310

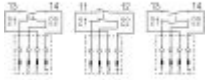

M12 connector with A-coding

Rated impulse withstand voltage U_{imp} : 0,8 kV

Rated insulation voltage U_i : 50 V

Operating current I_e : AC-15: 50 V / 4 A

Caution! The versions with connector may only be used in PELV circuits to EN 60204-1.

...-ST

Ordering code

(1)(2) 3(3)5-(4)Z(5)-(6)-(7)-(8)-(9)

(1)

Z Snap action

T Slow action

(2)

S Plunger S

R Roller plunger R

H Roller lever H

10H Rod lever 10H

7H Roller lever 7H

1K Offset roller lever 1K

3K Angle roller lever 3K

(3)

3 slim design

5 large design

(4)

11 1 Normally open contact (NO) / 1 Opener (NC)

02 2 Opener (NC)

20 2 Normally open contact (NO) (*Switch with 2 NO contacts are not for security tasks*)

01/01 1 Opener (NC) left / 1 Opener (NC) right

12 1 Normally open contact (NO) / 2 Opener (NC)

03 3 Opener (NC)

(5)

H Slow action with staggered contacts

UE Slow action with overlapping contacts

(6)

G24 with LED

(7)

without Cable entry M20

NPT cable entry NPT 1/2"

ST M12 connector with A-coding (*Caution! The versions with connector may only be used in PELV circuits to EN 60204-1.*)

2310 M12 connector with B-coding (*Caution! The versions with connector may only be used in PELV circuits to EN 60204-1.*)

(8)

2138 Roller lever 7H for Position switches with safety function

(9)

Documents

Operating instructions and Declaration of conformity (nl) 710 kB, 01.12.2009

http://www.schmersal.net/Bilddata/Si_f1/Pdf/Z332/bedien/NL/mrl_zt332-335-336-355_nl.pdf

Operating instructions and Declaration of conformity (pt) 586 kB, 01.03.2010

http://www.schmersal.net/Bilddata/Si_f1/Pdf/Z332/bedien/PT/mrl_zt332-335-336-355_pt.pdf

Operating instructions and Declaration of conformity (it) 513 kB, 01.12.2009

http://www.schmersal.net/Bilddata/Si_f1/Pdf/Z332/bedien/IT/mrl_zt332-335-336-355_it.pdf

Operating instructions and Declaration of conformity (cn) 797 kB, 02.03.2010

http://www.schmersal.net/Bilddata/Si_f1/Pdf/Z332/bedien/CN/mrl_zt332-335-336-355_cn.pdf

Operating instructions and Declaration of conformity (en) 605 kB, 22.03.2010

http://www.schmersal.net/Bilddata/Si_f1/Pdf/Z332/bedien/EN/mrl_zt332-335-336-355_en.pdf

Operating instructions and Declaration of conformity (de) 581 kB, 27.11.2009

http://www.schmersal.net/Bilddata/Si_f1/Pdf/Z332/bedien/DE/mrl_zt332-335-336-355_de.pdf

Operating instructions and Declaration of conformity (es) 516 kB, 27.11.2009

http://www.schmersal.net/Bilddata/Si_f1/Pdf/Z332/bedien/ES/mrl_zt332-335-336-355_es.pdf

Operating instructions and Declaration of conformity (jp) 677 kB, 27.11.2009

http://www.schmersal.net/Bilddata/Si_f1/Pdf/Z332/bedien/JP/mrl_zt332-335-336-355_jp.pdf

Operating instructions and Declaration of conformity (fr) 525 kB, 01.12.2009

http://www.schmersal.net/Bilddata/Si_f1/Pdf/Z332/bedien/FR/mrl_zt332-335-336-355_fr.pdf

CCC certification (en) 584 kB, 12.12.2006

http://www.schmersal.net/Bilddata/Si_f1/Pdf/Zt235/zertifikat/q_347p02.pdf

CCC certification (cn) 605 kB, 12.12.2006

http://www.schmersal.net/Bilddata/Si_f1/Pdf/Zt235/zertifikat/q_347p03.pdf

Images

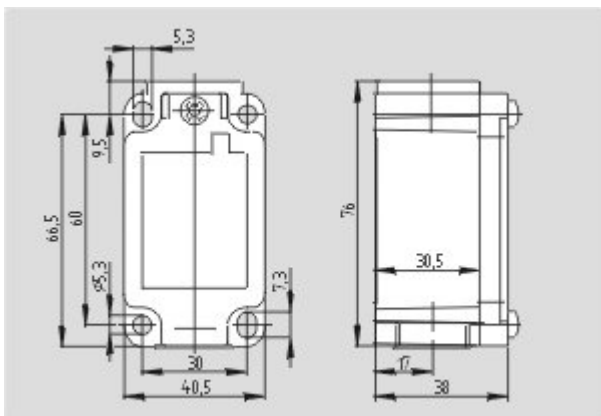

Dimensional drawing (basic component)

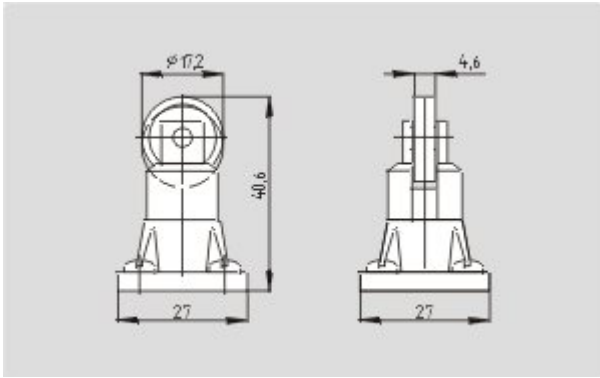

Dimensional drawing (actuator)

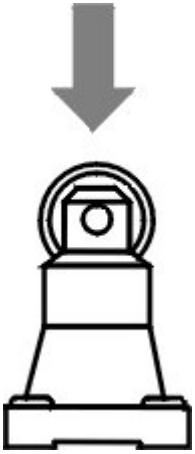

Operating principle