

S2 SERIES INSTRUCTION MANUAL

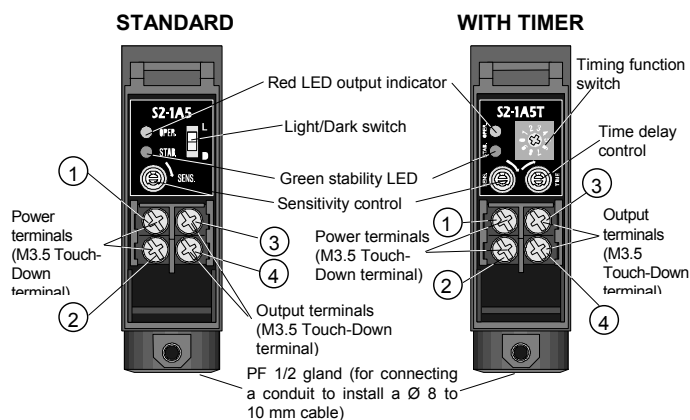

READING CHARACTERISTICS

| Model | Function | Operating distance |
|------------------------------|-----------------------|--------------------|
| S2-X-A5 (T) | Retroreflex | 0.1 ... 5 m * |
| S2-X-B3 (T) | Polarized retroreflex | 0.15 ... 3.5 m * |
| S2-X-C90 (T) S2-X-C200(T) | Proximity scanner | 0.9 m 2 m |
| S2-X-F10(T) S2-X-F50(T) | Receiver | 10 m 50 m |
| S2-X-G10 S2-X-G50 | Emitter | 10 m 50 m |

(T) = types with time-delay *using the attached R2 reflector

SPECIFICATIONS

| Type | F/G | A | B | C |
|------------------------------|--|--------------------------------|------------------------------|--------------------------------|
| Common specifications | | | | |
| Detectable Object | Opaque Ø16 mm min. | Opaque Ø60 mm min. | Opaque, Specular Ø60 mm min. | Opaque, Transparent |
| Hysteresis | - | - | - | 15% max. at 0.5 m |
| Emission | Infrared LED (Modulation mode) | Infrared LED (Modulation mode) | Red LED (Modulation mode) | Infrared LED (Modulation mode) |
| Ambient light rejection | Sunlight: 10.000 lux at receiver Incandescent lamp: 3.000 lux at receiver | | | |
| Operating temp. | -15°C ... 55°C | | | |
| Storage temp. | -25°C ... 70°C | | | |
| Humidity | 35 ... 85% RH (non condensing) | | | |
| Protection class | IP66 | | | |
| Vibration resistance | 0.5 mm amplitude, 10 ... 55 Hz frequency, for every axis (EN60068-2-6) | | | |
| Shock resistance | 11 ms (30 G) 6 shock for every axis (EN60068-2-27) | | | |
| (Time Delay Range) | 0.6 ... 16 sec. | | | |
| Housing | PBT plastic | | | |
| Multi-Voltage Type | | | | |
| Power supply | 15 ... 264 Vdc/Vac; 50/60 Hz (limit values) | | | |
| Power Consumption | 3 VA max. | | | |
| Output | Electromechanical relay 1 NO contact Rated load: 250 V AC/1A, 30 V DC/2A (resistive load) Minimum applicable load: 5 V DC, 1 mA (reference value) Electrical life: 100.000 operations min. Mechanical life: 10.000.000 operations min. | | | |
| Response Time | 20 msec max. | | | |
| Switching freq. | 25 Hz max. | | | |
| DC-Type | | | | |
| Power supply | 10 ... 30 V DC (limit values), ripple 2 Vpp max. included | | | |
| Current Consumption | F: 15 mA max. G: 20 mA max. | 30 mA max | | |
| Output | NPN and PNP transistor open collector Load current: 100 mA max. with a short-circuit protection Residual voltage: 1 V max. (NPN output) 2 V max. (PNP output) 30 V DC max. | | | |
| Response Time | 1 msec max. (2 msec max. for emitter/receiver) | | | |
| Switching freq. | 500 Hz max. (250 Hz max. for emitter/receiver) | | | |

CONNECTIONS AND PINOUTS

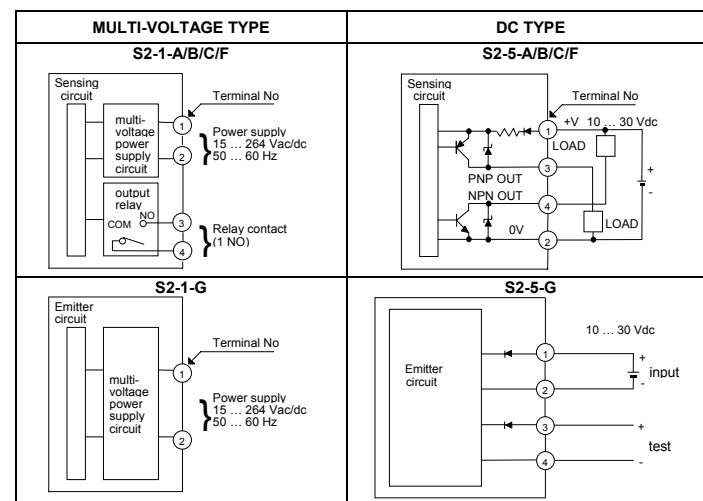

CABLE CONNECTION

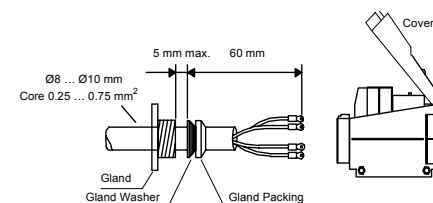

- Use a cable of 8 ... 10 mm in diameter to ensure water- and dust-proof characteristics. Two gland packings are supplied; for cables of 8 ... 9 mm and 9 ... 10 mm in diameter. Use a proper gland packing and a gland washer, and tighten the gland firmly.
- Keep the cable insulation within 5 mm from the gland packing as shown above. Make sure the gland washer is placed in the gland packing correctly.
- Connect wires to lower terminals 2 and 4 first, then upper terminals 1 and 3.
- Extension is allowed up to 100 m using a cable with cores of 0.3 mm² or more.

INSTALLATION

Screw Tightening Torque

Tighten screws enough to ensure watertight characteristics. Note that excessive tightening may cause damage.

| Screw | Torque |
|--------------------|------------------|
| Terminal Screw | 8 ... 12 kgf-cm |
| Gland | 10 ... 15 kgf-cm |
| Cover Fixing Screw | 5 ... 8 kgf-cm |
| Mounting Screw | 8 ... 12 kgf-cm |

Installing the Slit (Optional in Emitter/Receiver)

Slits are used to detect small objects or to increase the accuracy of detecting positions. Minimum size of detectable object and sensing distance are shown in the table below.

| Slit is attached to | Min. detectable object | Operating distance |
|---------------------|------------------------|--------------------|
| F or G | Ø 16 mm | 4 m |
| F and G | 3 x 10 mm | 2 m |

PRECAUTIONS

- When installing the photoelectric sensors adjacently, keep them apart from each other, or install a light barrier to prevent light interference. And pay attention to reflected light from the floor or wall.
- Make sure that fluorescent light does not enter into the receiver of the photoelectric sensor. Fluorescent lamps may effect the sensor operation depending on its location.
- Do not strike the photoelectric sensors with a hammer when installing, otherwise the waterproof characteristics will be impaired.
- To prevent transient spikes at power ON, an internal circuit keeps the output OFF (200 ms max.). On timer models (T), the time delay operation starts after this reset time.
- This cable should not be run in the same wire duct with other power supply, motor, or electromagnetic lines because induction noise will cause malfunction or damage to the photoelectric sensor.
- The lens is made of acrylic resin. Clean the lens with alcohol or a dry soft cloth. Do not use organic solvent such as thinner.
- Do not use the photoelectric sensor under conditions exceeding the rated operating temperature, vibration resistance and shock resistance.
- Use the photoelectric sensor within the rated power voltage. When using a switching power supply, connect its chassis to ground.

OPERATION CHART

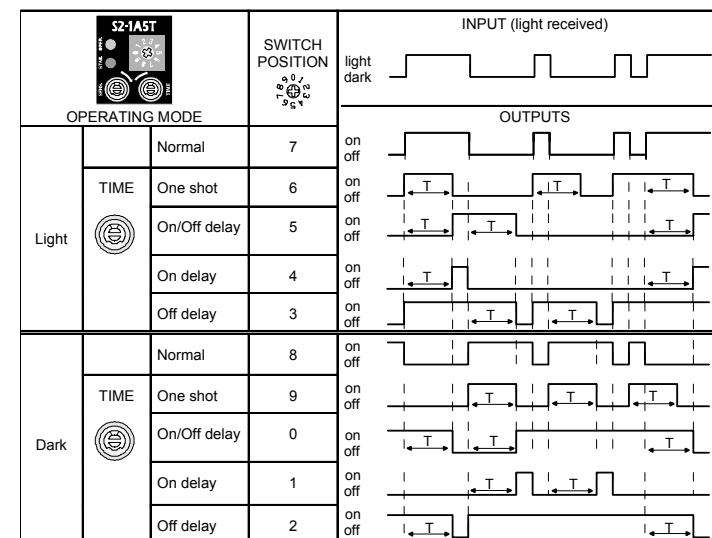

- Note 1: Timing functions are selected by a rotary switch.
 Note 2: The models without timing functions have only the Light/Dark selector switch and operate in the Normal mode.
 Note 3: The red output LED goes ON when the output is on and goes OFF when the output is off.

OPTICAL ALIGNMENT AND SENSITIVITY ADJUSTMENT

Align the sensor using the procedure for your model. Observe the action of the green LED stability indicator. The action of the red LED output indicator will change according to the mode selected (Light or Dark); for the following procedures Light Pulse operating is assumed.

Procedure for S2-x-A/B and S2-x-F/G

- Turn the sensitivity trimmer to maximum sensitivity.
- Place the S2 within the desired operating distance:



Move the S2 to align it until the green and the red LEDs are both ON.

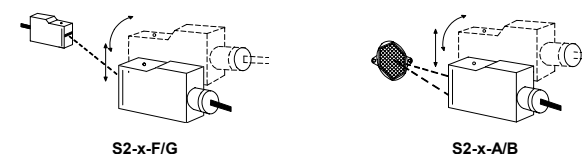

- Reduce the sensitivity by turning the trimmer counterclockwise until the red LED goes OFF.
- Move the S2 until both LEDs go ON. The stable functioning is obtained through a better alignment.
- Repeat steps 3 and 4 until it is impossible to reach a stable condition without increasing the sensitivity.
- The S2 is now correctly aligned. Fix the device in this position and slightly increase the sensitivity until the green and the red LEDs are both ON: **stable functioning.**

NOTE for S2-x-A/B

When the object is glossy or has a high reflection factor, use the Retro-reflex w/polarization filter type (S2-x-B3). In case of using the Retro-Reflex type S2-x-A5 on reflective objects, skew the sensor to avoid the high reflection as shown below.

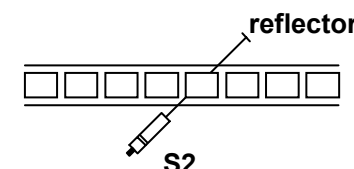

Procedure for S2-x-C

- Position the sensor with the sensitivity trimmer at minimum:

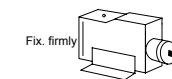

the green LED is ON, the red LED is OFF.

- Put the object to be detected in the sensing range:

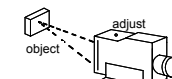

- Turn the sensitivity trimmer clockwise from MIN position until the red LED goes ON. Light is received. (A):



- Remove the object. The red LED goes OFF. Turn the trimmer clockwise until the red LED goes ON again. The background is detected. B = MAX if the background is not detected. (B):



- Adjust the trimmer to a medium position (C) between A and B to get the best sensitivity. The green LED must be ON.



STABILITY INDICATOR/GREEN LED

The stability LED indicates the level of the received input signal and makes the alignment of the photoelectric sensors easier. The photocell must operate in a stable condition, i.e. when the green LED is on. That means the light on the photocell receiver must be 30% lower or 30% higher than the value necessary to switch the output (100%-output switching level).

| CONDITIONS | STABILITY LED (Green) | OUTPUT LED (Red) | |
|-----------------|-----------------------|------------------|-----|
| | | ON | OFF |
| stable (1) 130% | ON | ON | OFF |
| unstable 100% | OFF | ON | OFF |
| | OFF | OFF | ON |
| stable (2) 70% | ON | OFF | ON |
| 0% | ON | OFF | ON |

(1) = stable when the signal is received
 (2) = stable when the signal is not received

TEST INPUT (DC EMITTER MODEL) S2-5-G

The TEST inputs (TEST+ and TEST-) inhibit emission pulses and allow correct functioning of the emitter/receiver pair to be verified. To perform the test there must be no target between the emitter and the receiver. The receiver output has to switch every time a voltage of 10 ... 30 Vdc is applied across the inputs TEST+ and TEST-, respecting the polarities. In case of dirty lenses or loss of optical alignment, the receiver will not receive the pulses and its output will not switch during testing. The test function is used to test sensors from remote locations and is a preliminary control of correct system functioning without any target being present.

DECLARATION OF CONFORMITY

We DATASENSOR S.p.A. declare under our sole responsibility that these products are conform to the 2004/108 CEE, 2006/25/CE Directives and successive amendments.



WARRANTY

DATASENSOR S.p.A. warrants its products to be free from defects. DATASENSOR S.p.A. will repair or replace, free of charge, any product found to be defective during the warranty period of 36 months from the manufacturing date. This warranty does not cover damage or liability deriving from the improper application of DATASENSOR products.

DATASENSOR S.p.A. Via Lavino 265
 40050 Monte S. Pietro - Bologna - Italy
 Tel: +39 051 6765611 Fax: +39 051 6759324
 http://www.datasensor.com e-mail: info@datasensor.com



DATASENSOR S.p.A. cares for the environment: 100% recycled paper. DATASENSOR S.p.A. reserves the right to make modifications and improvements without prior notification.